

Art. Nr. 1912296
1/10

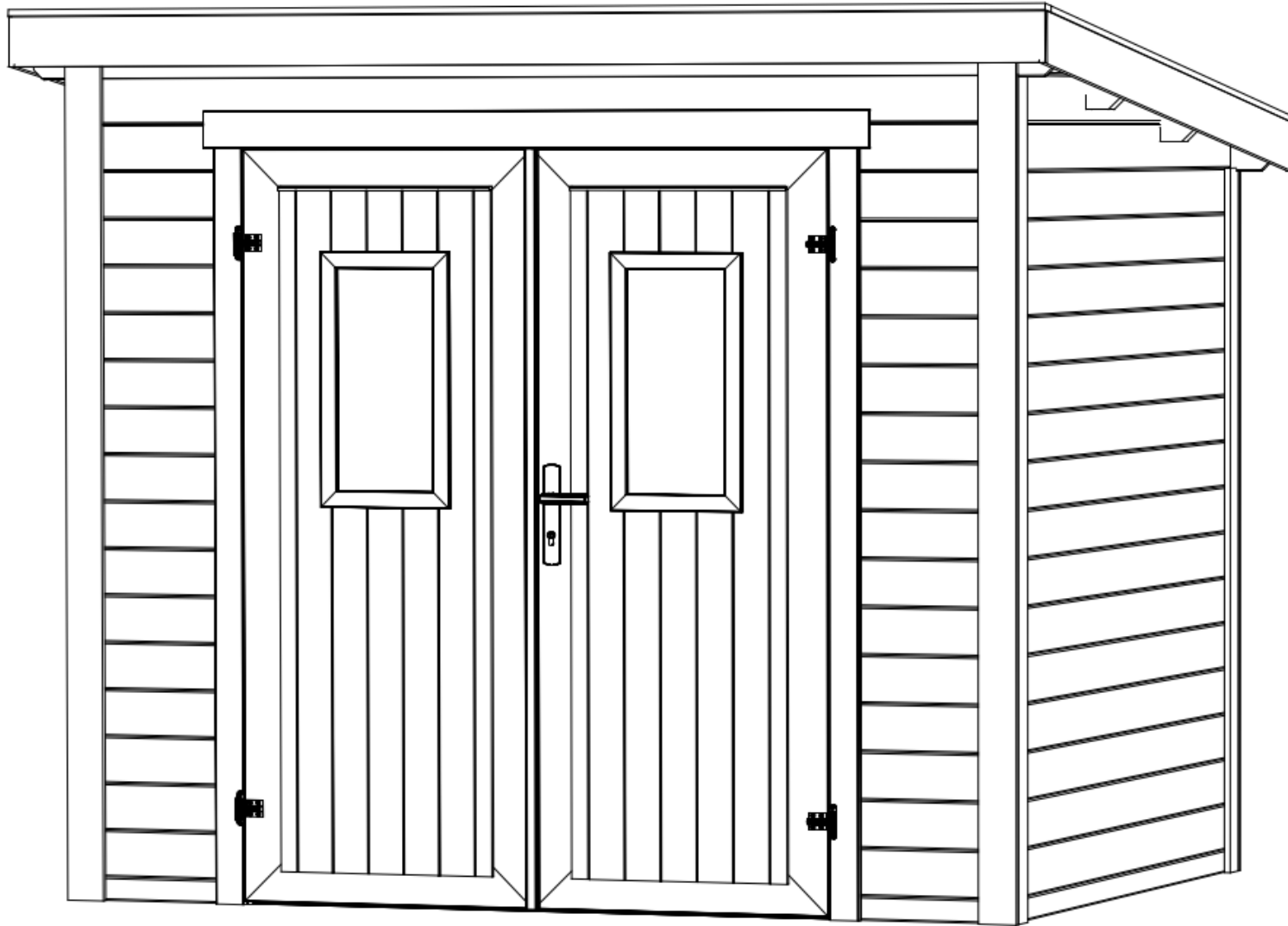







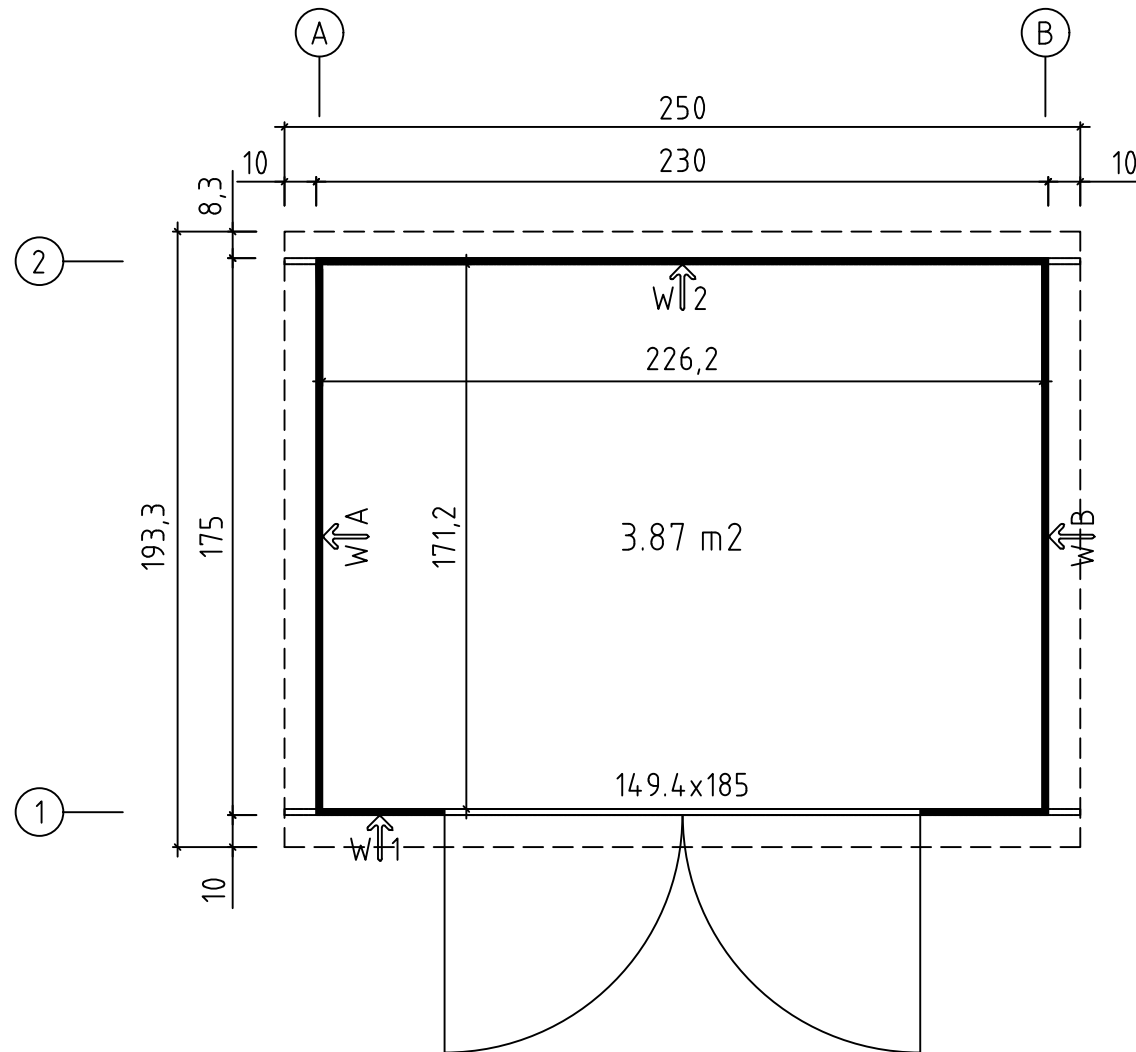

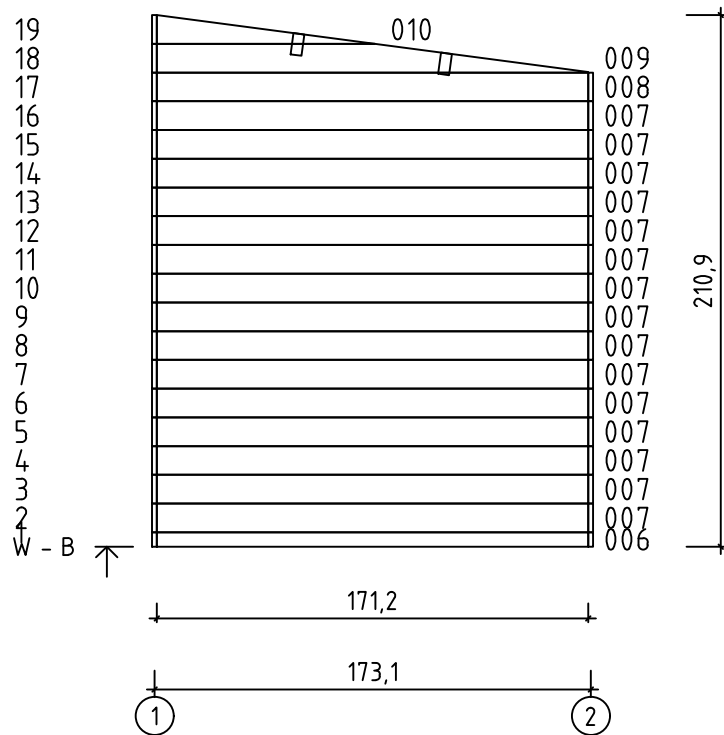
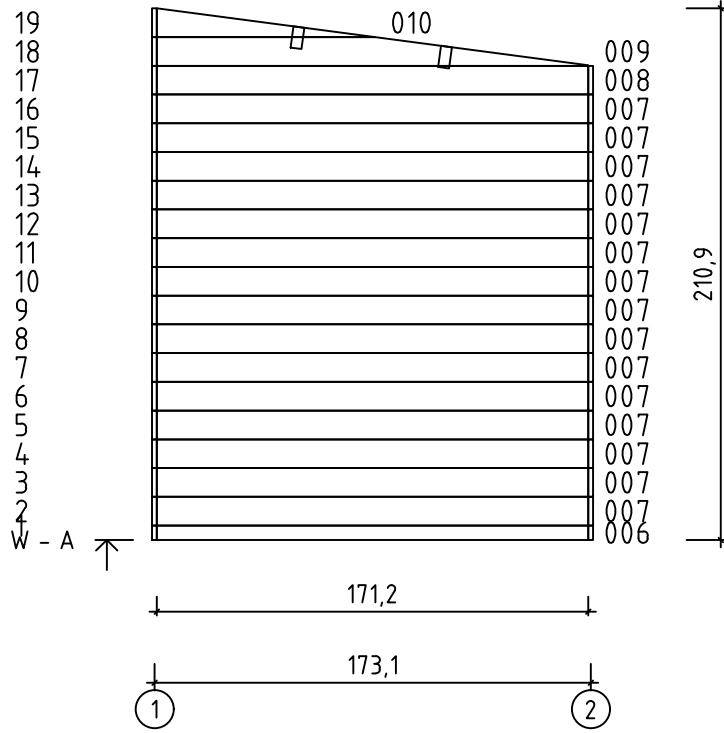

03.02.2026

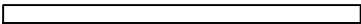
Art.Nr. 1912296

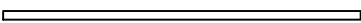
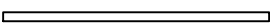
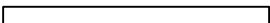
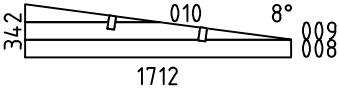
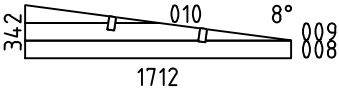
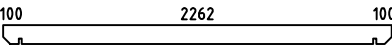
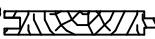
Groundplan - Grundplan - Plan de masse -
Planimetria - Plattegrond - Põhiplaan

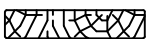
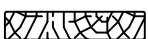
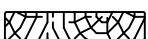
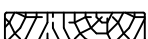



Pos	Piece list - Stückliste - Liste des pièces - Elementi - Stuklijst - Elementos - 03.02.2026 Tükítábel Art.Nr. 1912296	5/10	Q	P (mm)	L (mm)
001 52713			2	19x57	398
002 52712			32	19x114	398
003 31541			16	19x114	2300
004 52715			2	19x114	2500
005 52721			1	19x57	2300
006 52720			2	19x57	1712
007 52717			30	19x114	1712
WA-1 52727			1		
WB-1 52727			1		
A-PR1 52728	Roof beam - Dachbalken - Panne de toit - Perlina del tetto - Gordingen / dakbalk - Correa - Pärilin 		2	44x120	2500
RB-1 32560	Roof boards - Dachbretter - Voliges - Perlina per tetto - Dakhout - Tablero de tejado - Katuselaud 		28	90x15.5	1950
DPL-1 43588	Roofing felt fillet - Dachpappenleiste - Baguette de fixation du feutre bitumeux - Asse per fissaggio guaina bituminosa - Afdeklijst asfaltpapier - Moldura de fieltro para tejado - Katusepapiiliist 		2	15x45	1970
DPL-2 34484	Roofing felt fillet - Dachpappenleiste - Baguette de fixation du feutre bitumeux - Asse per fissaggio guaina bituminosa - Afdeklijst asfaltpapier - Moldura de fieltro para tejado - Katusepapiiliist 		1	15x45	2530
TBE7-1 39886	Corner fillet - Deckleiste - Profils de finition angles a l'exterieur - Massello d'angolo - (hoek)lijst - Moldura de esquina - Nurgaliist 		2	15x70	1767
TBE7-2 23516	Corner fillet - Deckleiste - Profils de finition angles a l'exterieur - Massello d'angolo - (hoek)lijst - Moldura de esquina - Nurgaliist 		2	15x70	1881
TBE7-3 39988	Corner fillet - Deckleiste - Profils de finition angles a l'exterieur - Massello d'angolo - (hoek)lijst - Moldura de esquina - Nurgaliist 		2	15x70	1995
TBE7-4 23517	Corner fillet - Deckleiste - Profils de finition angles a l'exterieur - Massello d'angolo - (hoek)lijst - Moldura de esquina - Nurgaliist 		2	15x70	2109
P2-1 47670	Post - Pfosten - Poteau - Piede registrabile - Stijl - Poste - Post 		2	44x44	1870
P2-2 42239	Post - Pfosten - Poteau - Piede registrabile - Stijl - Poste - Post 		2	44x44	2100
TB3-1 51660	Fascia board - Traufbrett - Bandeau de toit - Finitura lati tetto - Gevellijst - Tablero de alero - Räästalaud 		2	15x120	2000
TB3-2 34486	Fascia board - Traufbrett - Bandeau de toit - Finitura lati tetto - Gevellijst - Tablero de alero - Räästalaud 		1	15x120	2530

Art. Nr. 1912296

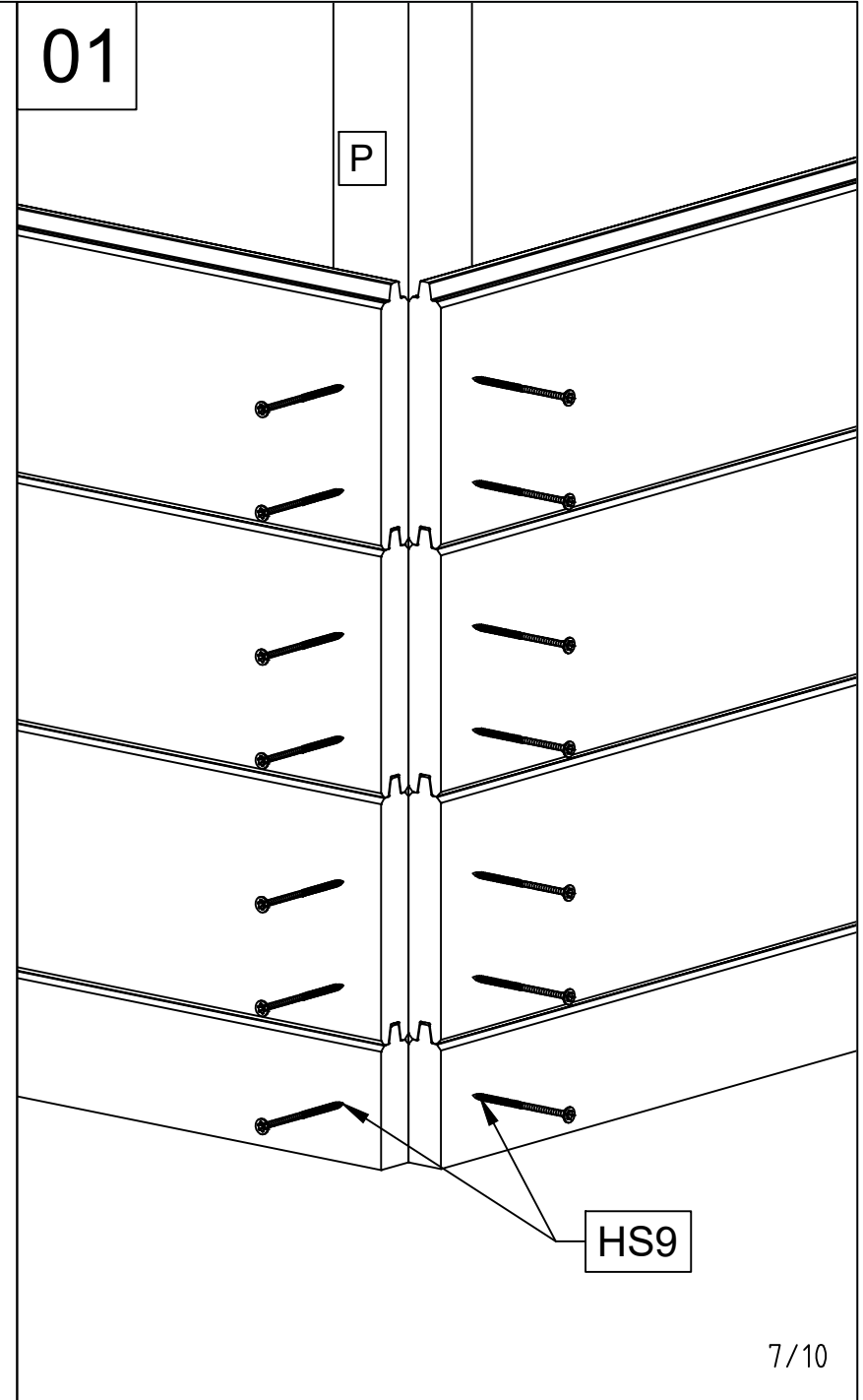
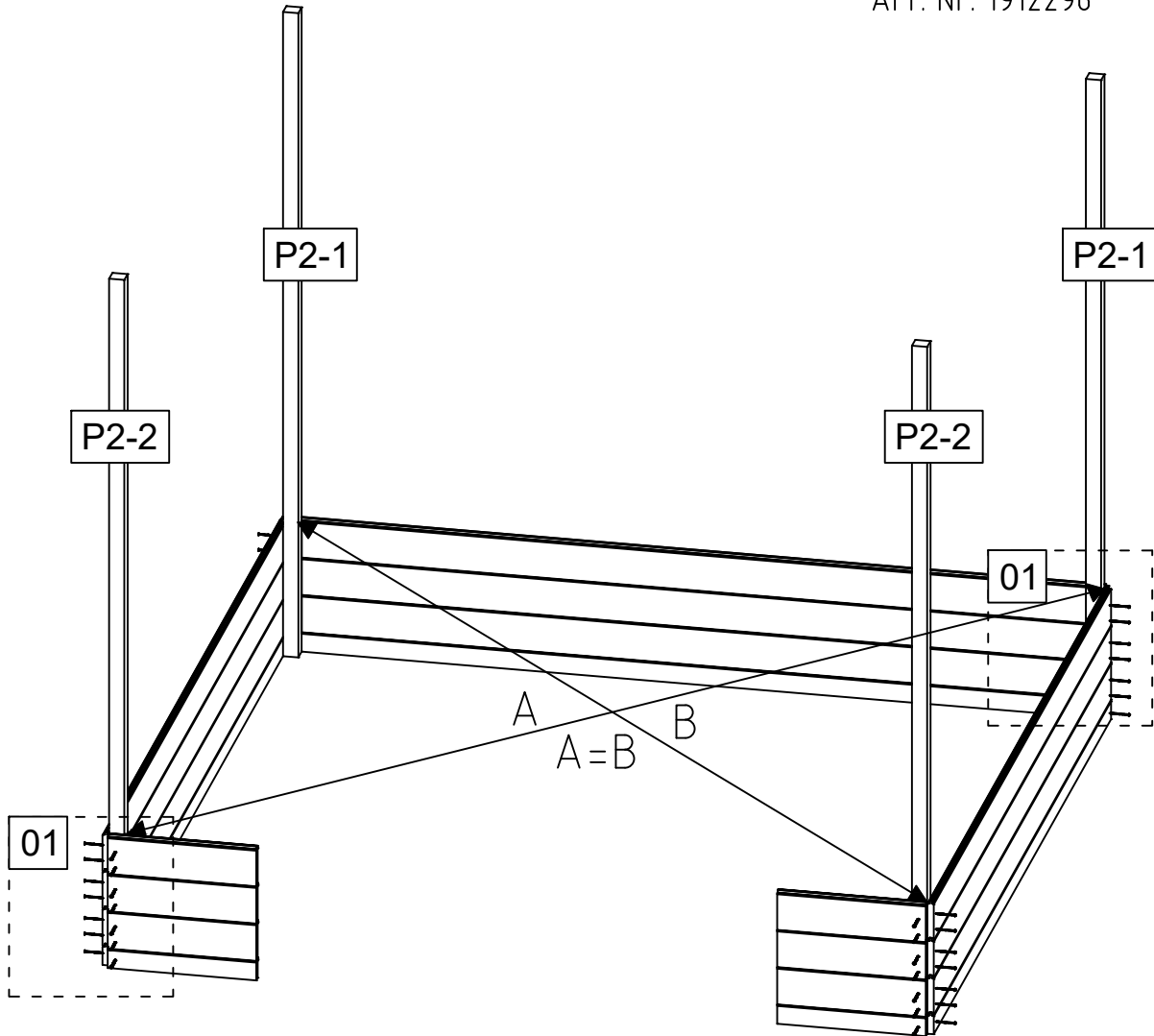

Art. Nr. 1912296

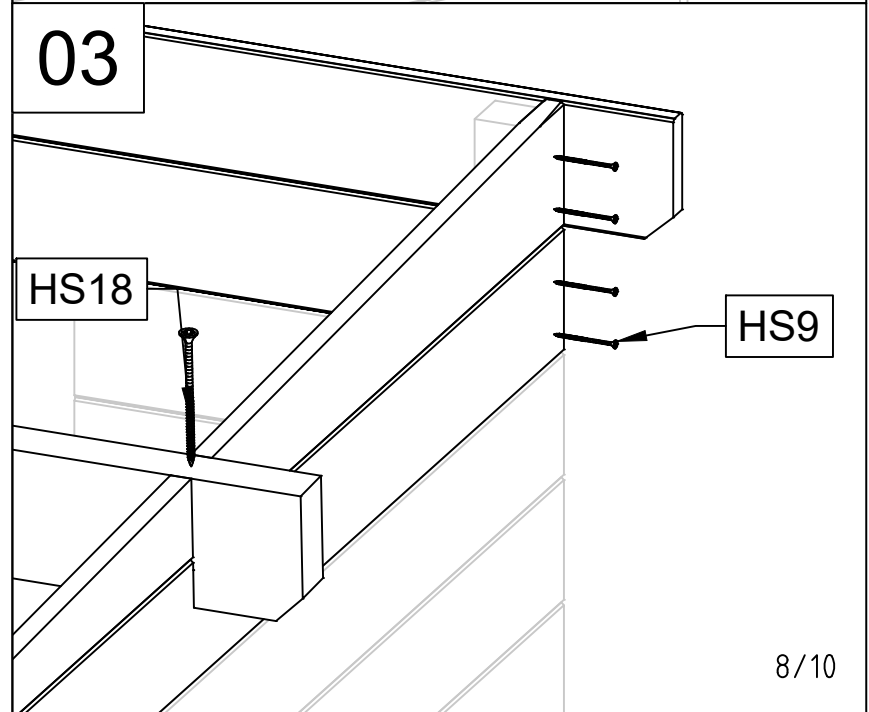
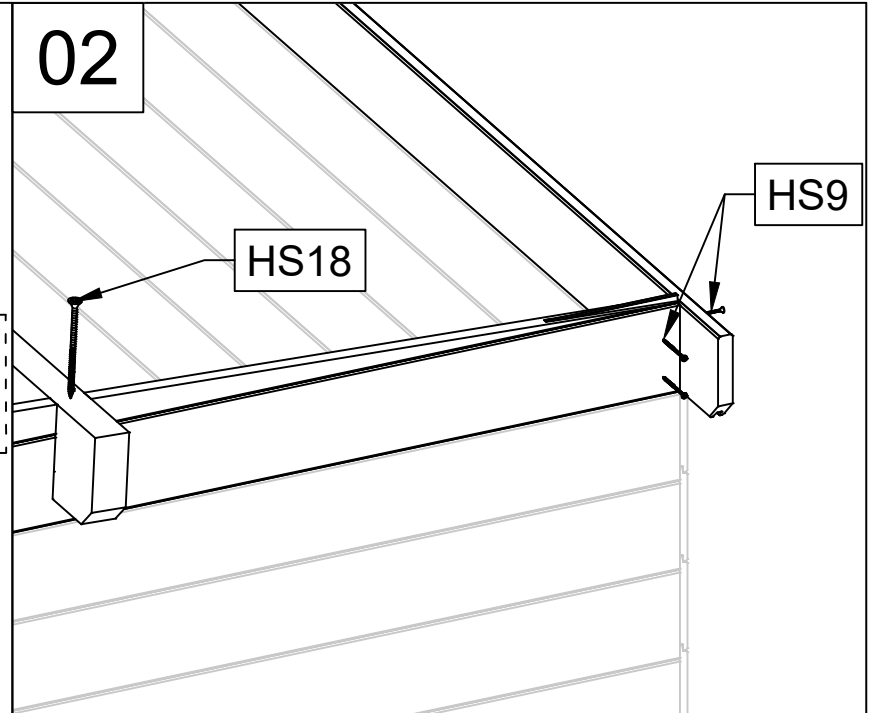
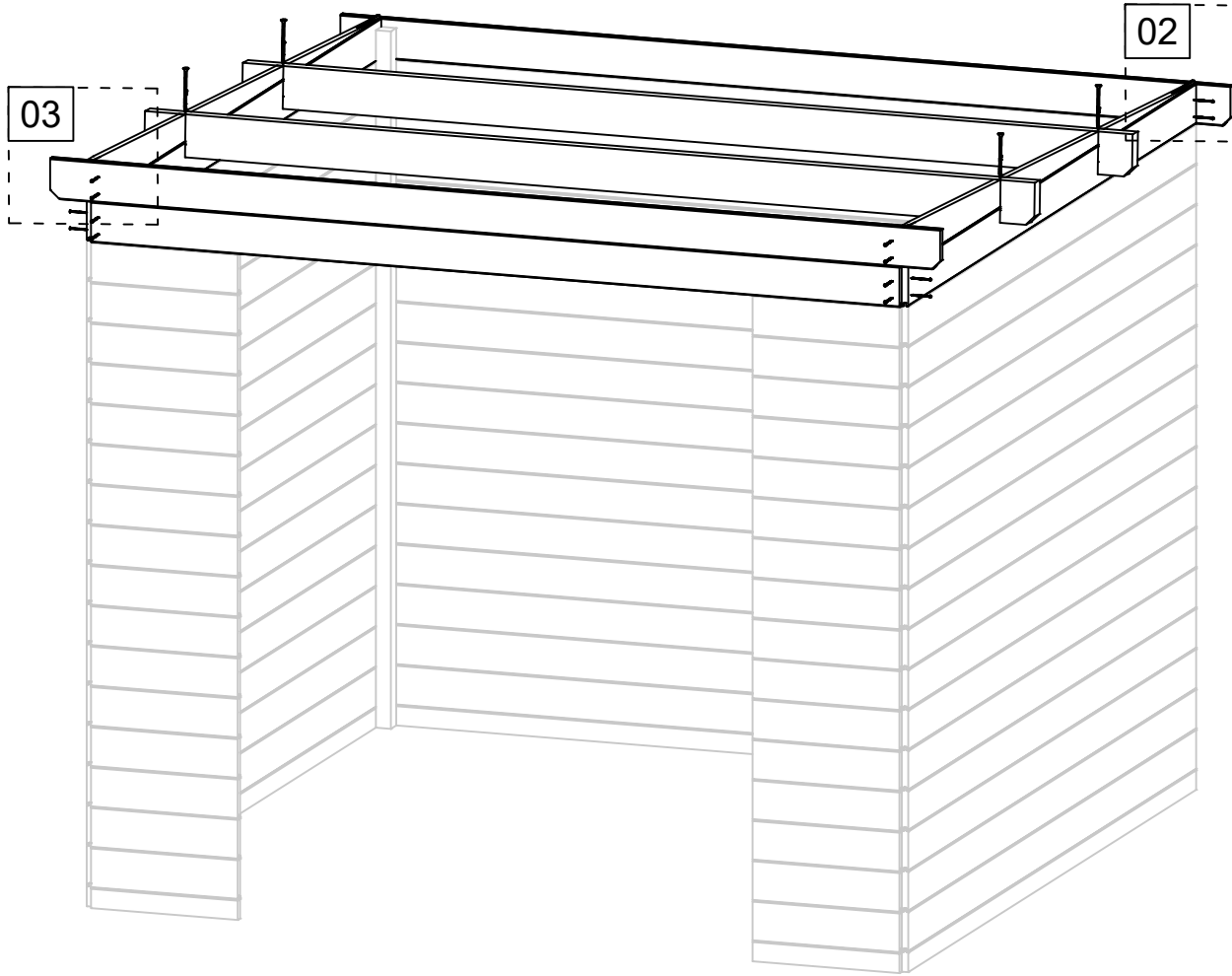



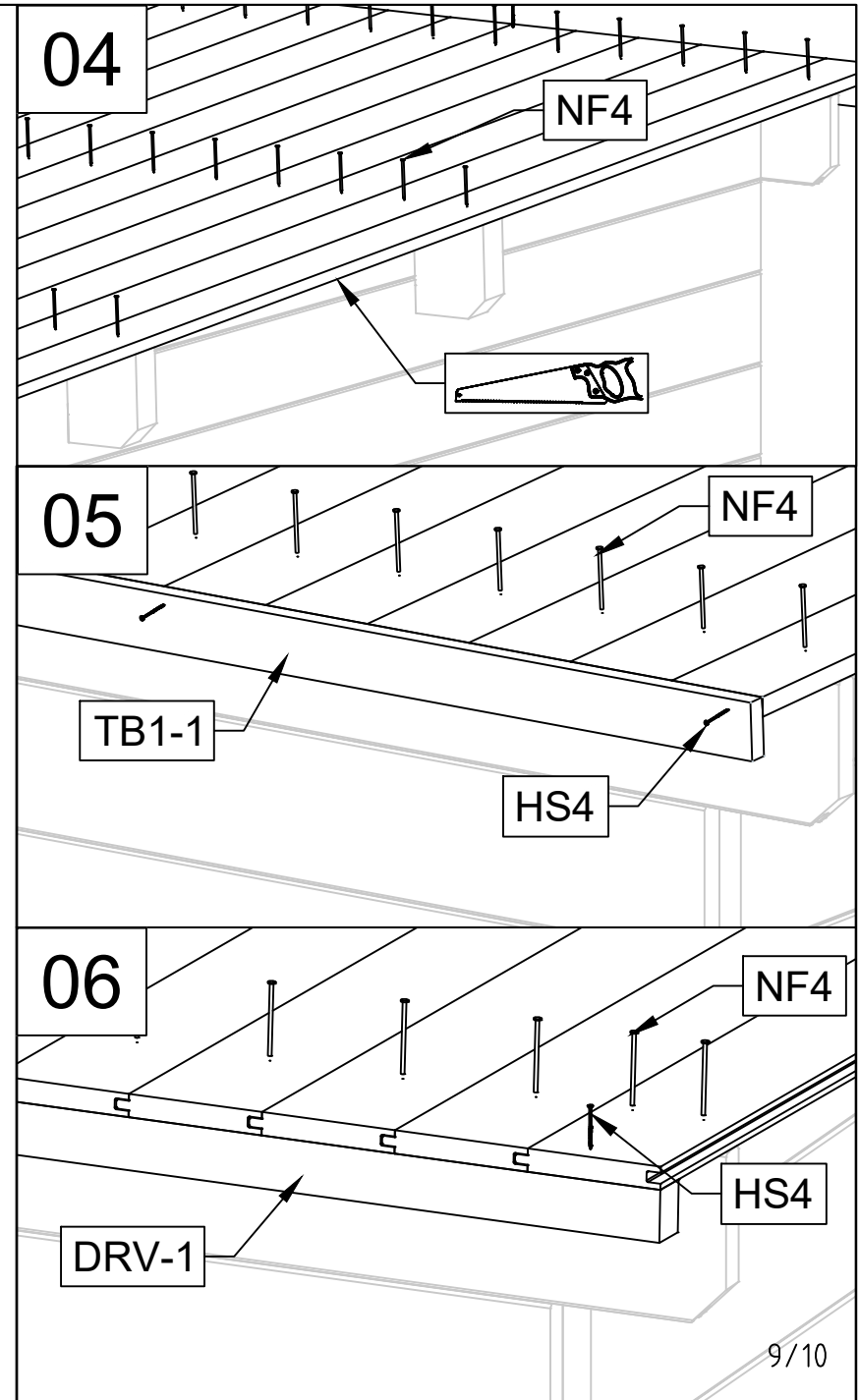
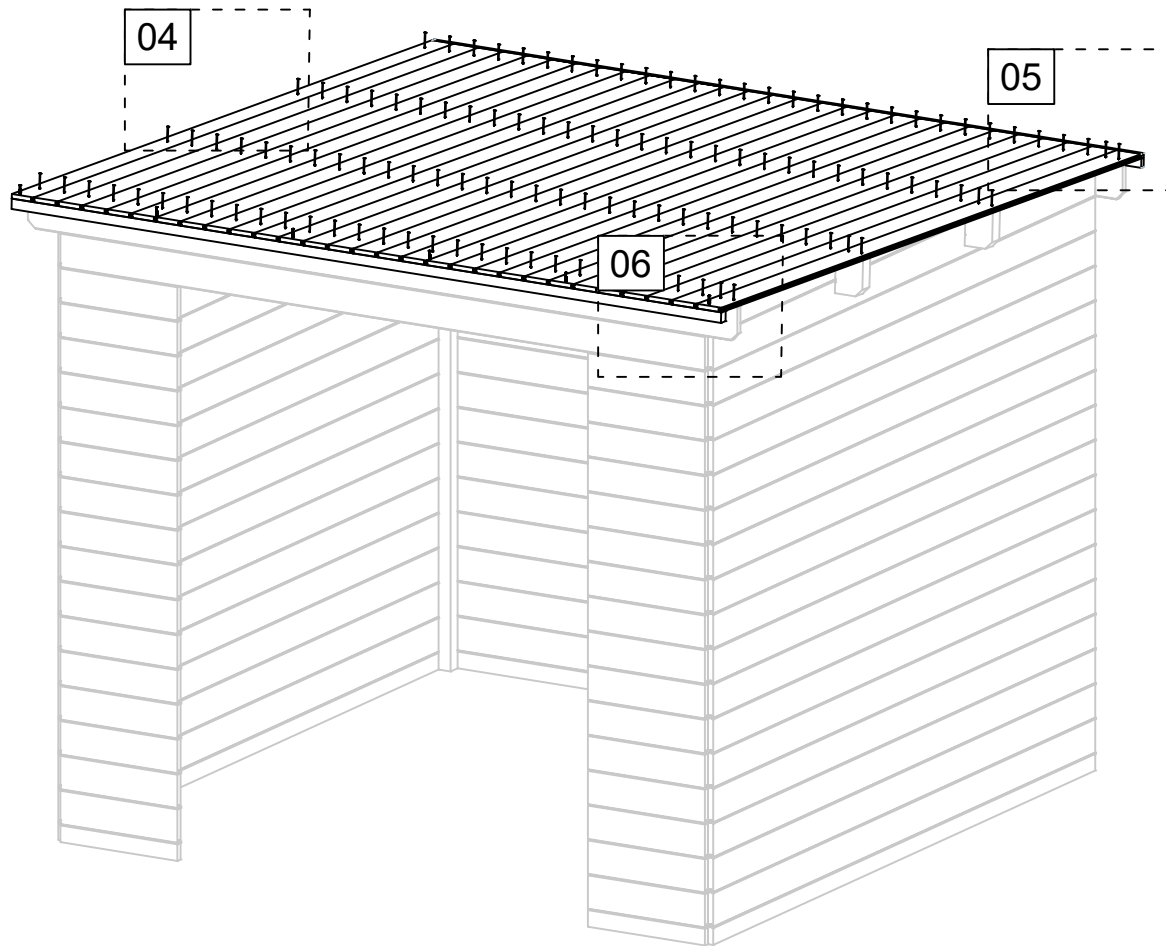



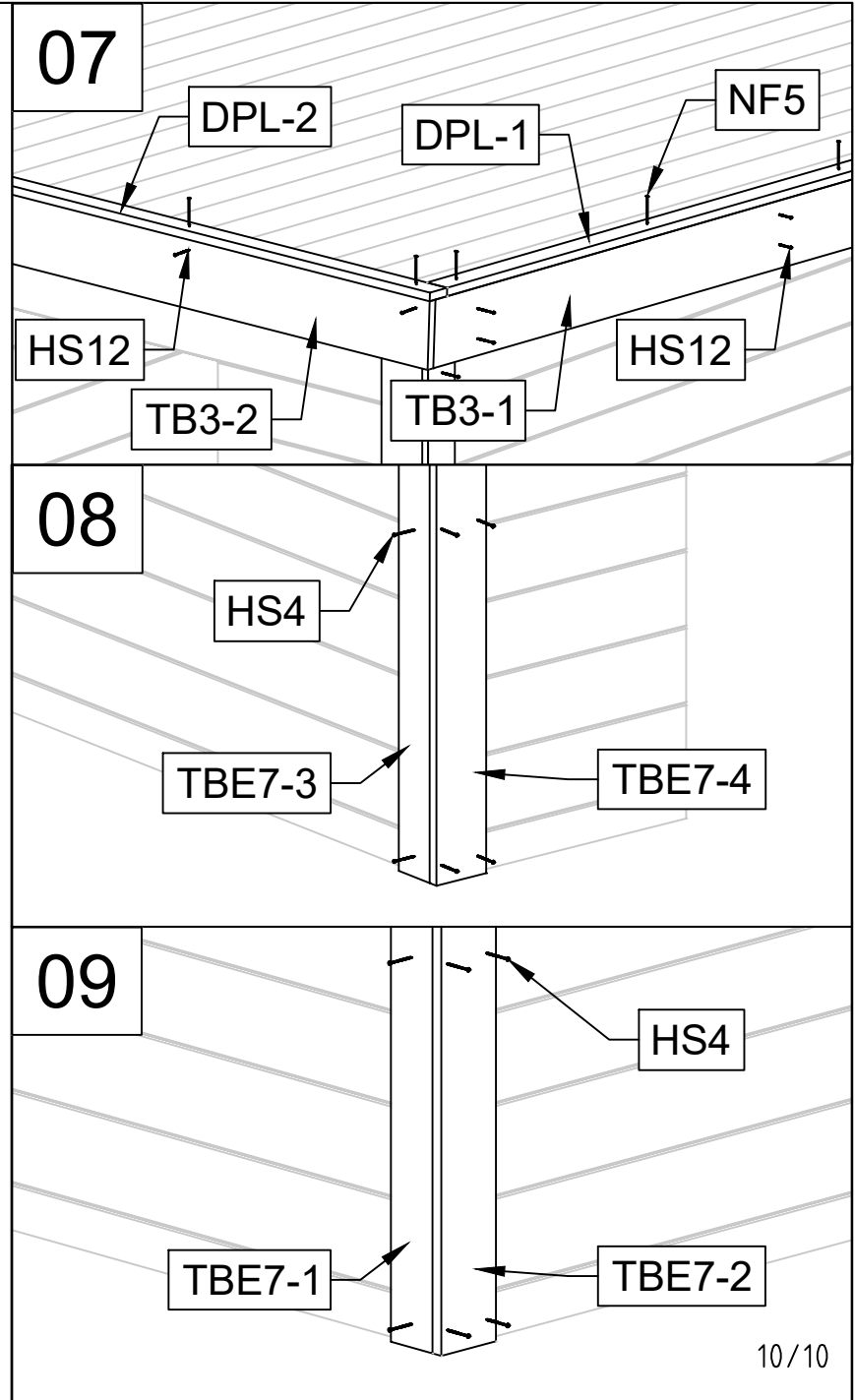
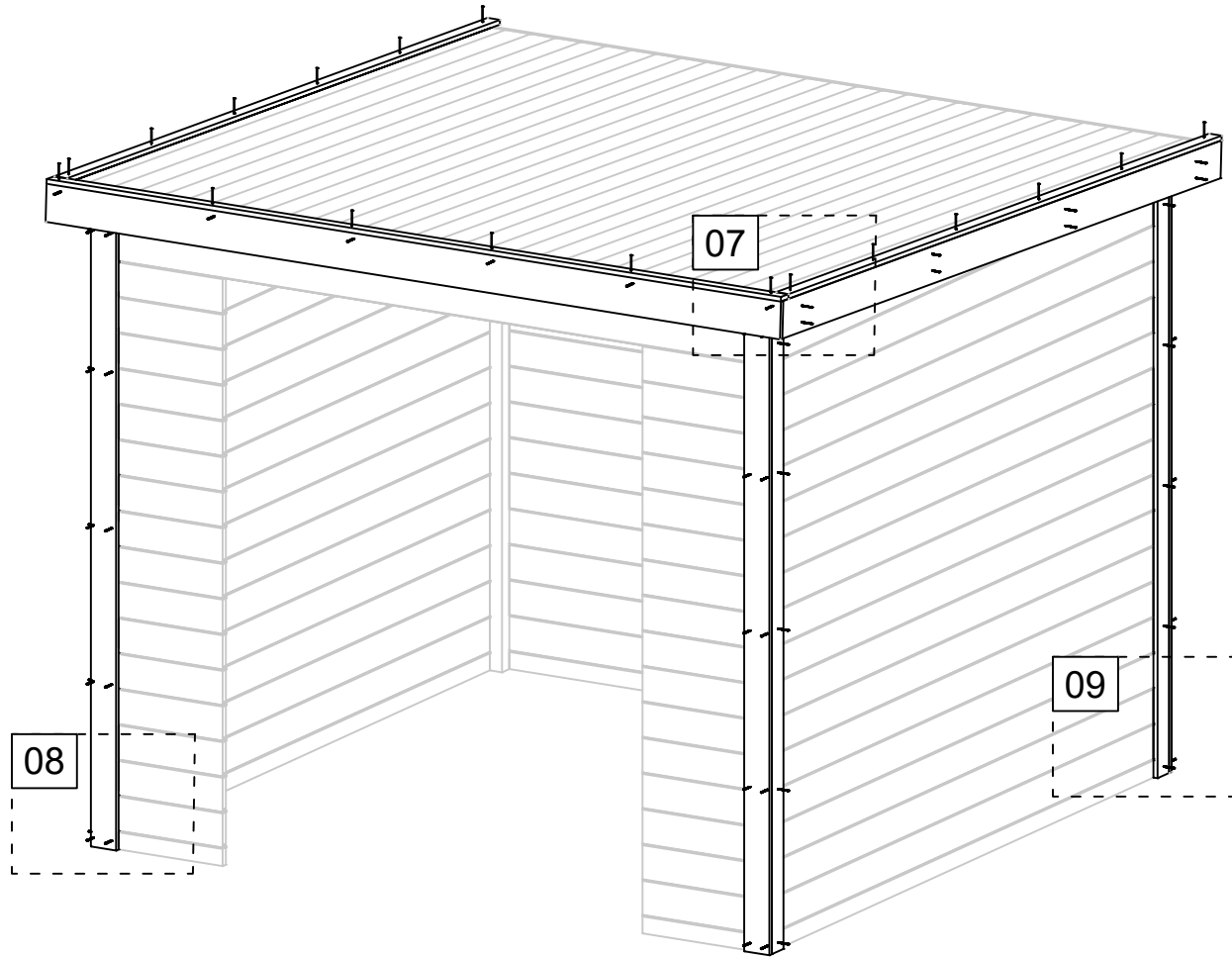

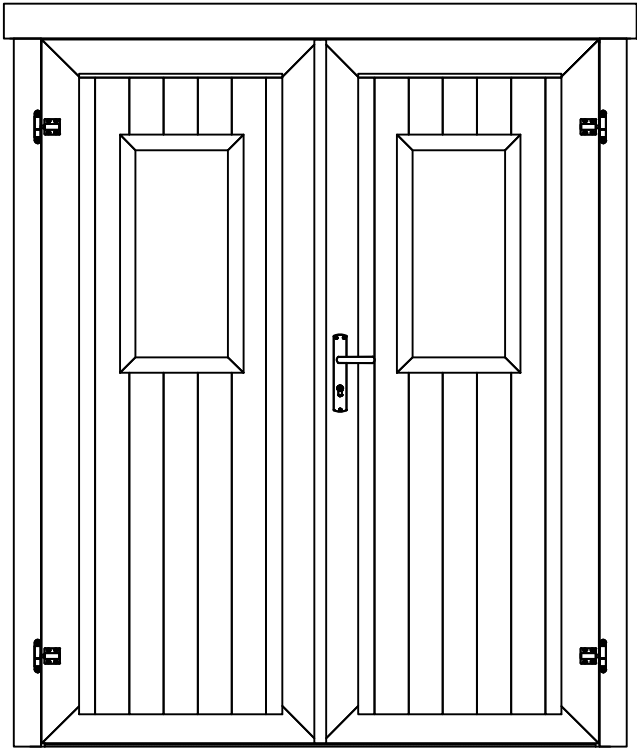
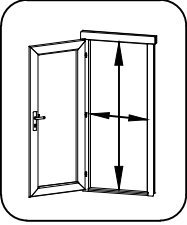

Art. Nr. 1912296



Art. Nr. 1912296



Pos	25.11.2025 Piece list - Stückliste - Liste des pièces - Elementi - Stuklijst - Tükítabel 1494x1850 TUK.2.010.XVP.MMX19 XGA+28	1/2	Q	P (mm)	L (mm)
	Glass size - Glasgröße - Taille de la vitre - Misura del vetro - Glas afmeting - Klaasi mõõt: 262x549 mm				
	  <p>1418x1794 mm</p>				
1	Upper door jamb - Türrahmen oben - Cadre de porte supérieur - Telaio superiore della porta - Bovendorpel - Ukse ülemine leng		1	66x100	1628
2	Left door jamb - Türrahmen links - Cadre de porte gauche - Telaio montante sinistro della porta - Linkerstijl deurframe - Ukse vasak leng		1	66x80	1850
3	Right door jamb - Türrahmen rechts - Cadre de porte droit - Telaio montante destro della porta - Rechterstijl deurframe - Ukse parem leng		1	66x80	1850
4	Doorstep - Swelle - Barre de seuil - Soglia della porta - Deurdorpel - Lävepak		1	18x18	1418
5	Connection strip - Deckleiste - Baguette de battement - Profilo verticale della porta - Stulpelijst - kokkuvaltsiliist		1	13x30	1812
6	Window fillet - Glasleiste - Cadre de vitre - listello per finstra - Glaslijst - Klaasiliist		4	20x40	318
7	Window fillet - Glasleiste - Cadre de vitre - listello per finstra - Glaslijst - Klaasiliist		4	20x40	613
8	Window fillet - Glasleiste - Cadre de vitre - listello per finstra - Glaslijst - Klaasiliist		4	10x40	318
9	Window fillet - Glasleiste - Cadre de vitre - listello per finstra - Glaslijst - Klaasiliist		4	10x40	613
10	Glass - Glas - Vitre - Vetro - Glas - Klaas		2		

